

SALUS[®]

C O N T R O L S

Model: RT310i

Smartphone Controlled Thermostat



Installation Manual

| | |
|--|----|
| Product Compliance | 3 |
| Safety Information | 3 |
| Introduction | 4 |
| Overview | 5 |
| Box contents | 5 |
| Features | 5 |
| Connecting the RXRT510 receiver | 6 |
| Installation | 6 |
| RT310i thermostat | 7 |
| Connecting the iTG310 Gateway | 7 |
| Test Pairing Function | 7 |
| Registration | 8 |
| Button functions and keys | 9 |
| LCD and App icons | 10 |
| Operations | 11 |
| Temperature, clock, time format | 11 |
| Heat/Cool Mode | 12 |
| Setting schedules | 14 |
| Temporary or Permanent Override program mode | 15 |
| Frost Protection | 16 |
| Holiday Mode | 17 |
| Distance alerts | 17 |
| Other functions | 18 |
| LCD backlight | 18 |
| Low battery detection | 18 |
| Temperatures outside operating range | 18 |
| Operating in Offline Mode | 19 |
| Reviewing Setpoint Temperature via device | 19 |
| Adjusting setpoint via device | 19 |
| Factory reset | 20 |
| Technical info | 21 |
| Warranty | 22 |

Product Compliance

This product complies with the essential requirements and other relevant provisions of the following EU Directives: 2014/30/EU, 2014/35/EU, 2014/53/EU and 2011/65/EU. The full text of the EU Declaration of Conformity is available at the following internet address: www.saluslegal.com.

Safety Information

Use in accordance with the EU and national regulations. For indoor use only. Keep your device completely dry. This product must be installed by a competent person and in accordance with all the EU and national regulations.



Always isolate the AC Mains supply before installing or working on any components that require 230 VAC 50Hz supply.

A room thermostat simply switches the heating system on and off as necessary. It works by sensing the air temperature, switching on the heating when the air temperature falls below the thermostat setting, and switching it off once this set temperature has been reached.

The SALUS RT310i is a Smart phone controlled programmable thermostat. The RT310i thermostat will switch your heating system on or off, as needed, in accordance with the temperature set by you, locally on the device or remotely using the dedicated app.

Turning a room thermostat to a higher setting will not make the room heat up any faster. How quickly the room heats up depends on the design of the heating system, for example, the size of boiler and radiators. Neither does the setting affect how quickly the room cools down. Turning a room thermostat to a lower setting will result in the room being controlled at a lower temperature, and saves energy.

The heating system will not work if a time switch or programmer has switched it off.

The way to set and use your room thermostat is to find the lowest temperature setting that you are comfortable with, and then leave it alone to do its job. The best way to do this is to set the room thermostat to a low temperature – say 18°C – and then turn it up by one degree each day until you are comfortable with the temperature.

Room thermostats need a free flow of air to sense the temperature, so they must not be covered by curtains or blocked by furniture. Nearby electric fires, televisions, wall or table lamps may prevent the thermostat from working properly.

Overview

The RT310i is a stylish thermostat with easy readable LCD and a user-friendly interface. The Receiver is used for wiring connections and heat on/off control. The thermostat provides the user interface and temperature sensing / control. The two units are linked together by a Radio Frequency (RF) signal. The Gateway has a futuristic design and helps connect your devices to the Internet, so that they can be controlled over the RT310i App on your smart-phone.

Box contents



RT310i thermostat



RXRT510 receiver



4x screws and plugs

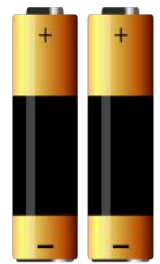

2x AA batteries



iTG310



ADSL Cable



Gateway Adaptor suitable for UK and EU



Quick Guide

Features

- Remote control via App
- 5/2 days or 24hrs programming flexibility via App
- Built-in start up programming for quick installation
- Frost protection
- Eco Mode
- Holiday Mode
- Large, easy to read LCD with blue backlight
- User friendly
- Stylish casing
- Geo Location
- Pre-paired from Factory
- RF Test Mode

Connecting the RXRT510 receiver

Unscrew the backplate of the RXRT510 receiver in order to do the wiring connections. After that please switch the receiver ON.

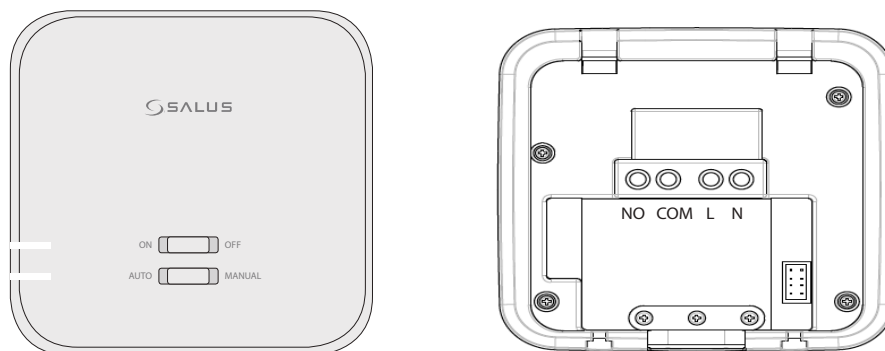

| Terminal | Description | Receiver Terminals |
|----------|------------------------|--------------------|
| NO | Switch Terminal | |
| COM | Common Switch Terminal | |
| L | Mains Live (230VAC) | |
| N | Mains Neutral | |



Wiring

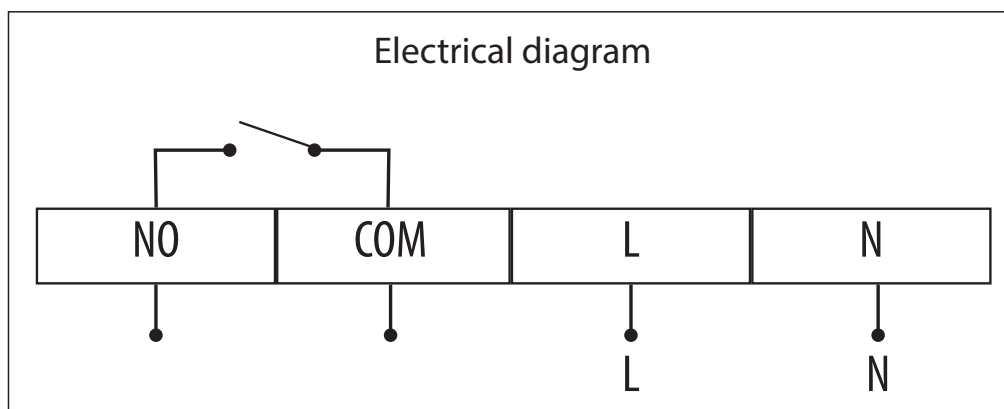

Wall mounting



Fix the backplate to the wall



Align the front housing at the top edge.



Fit the front housing. Press lightly

RT310i thermostat

Before inserting the batteries, please make a note of your SRT number and register your device on the App.

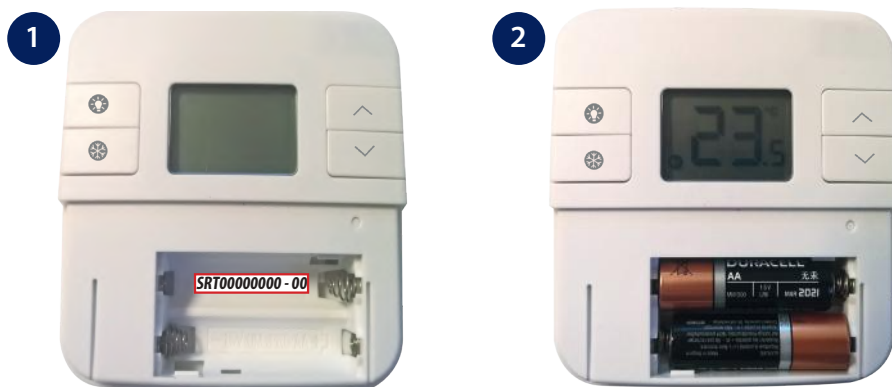

SRT□□□□□□□□-□□

Connecting the iTG310 Gateway

Plug in your gateway and attach the Ethernet cable and plug in into your router. The Led on the gateway will flash red 3 times, then it should be steady green.

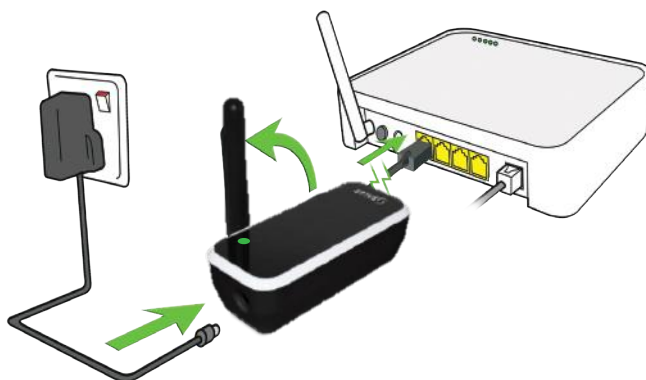

Gateway is ready for pairing

Test Pairing Function

Press the button once to test the connection between the thermostat and the receiver. If the devices are paired the ON and AUTO LEDs will both flash. You can wait 9 minutes for the process to end or can press the button again to stop.

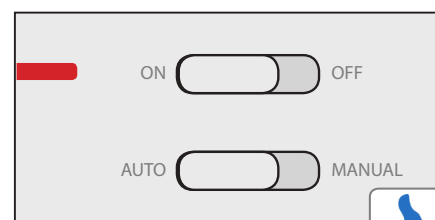
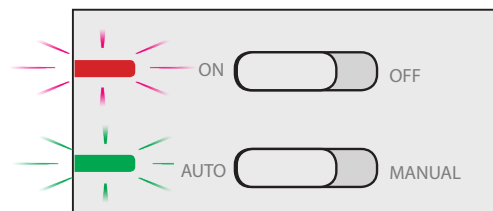
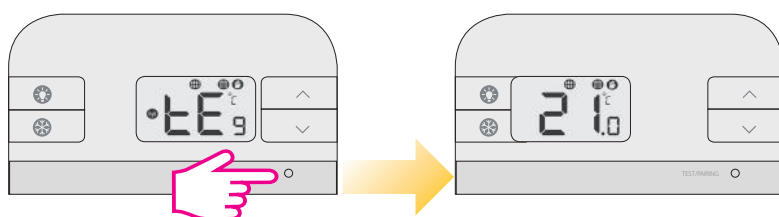
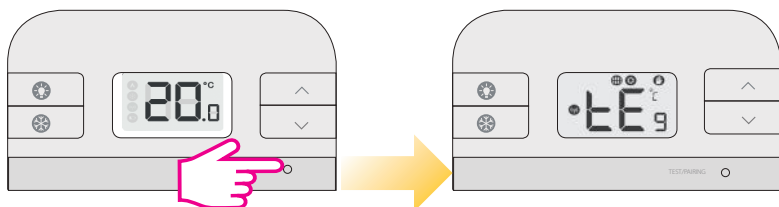

Registration

Download the RT310i App and create an account to start controlling your thermostat via the App. Please follow the steps below.

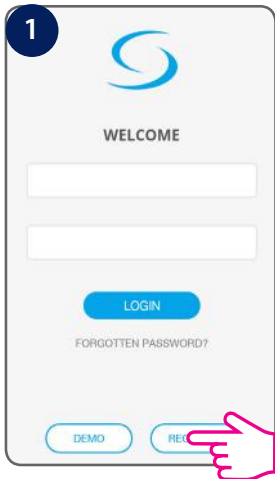

Tap register to create a new account

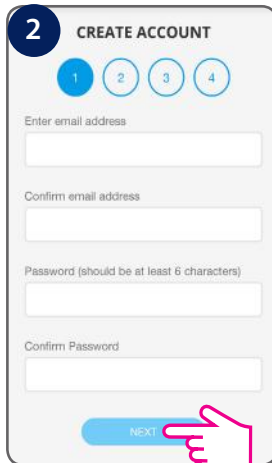

Enter email and password, tap Next

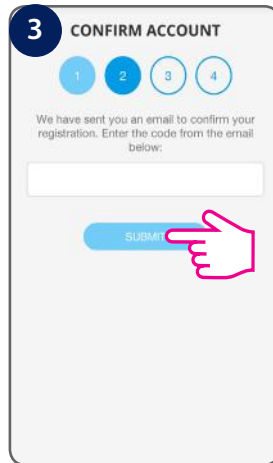

Enter the code you received via email

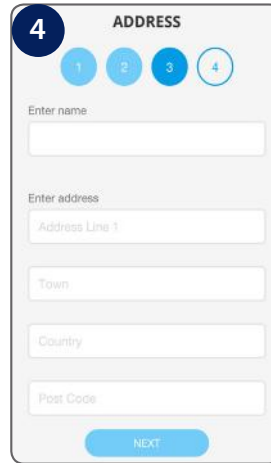

Enter name and address and tap Next

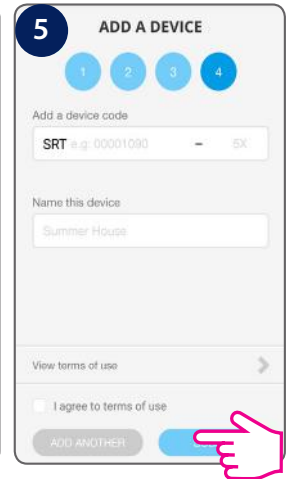

Enter the SRT device code. Read and accept the terms. Tap Submit

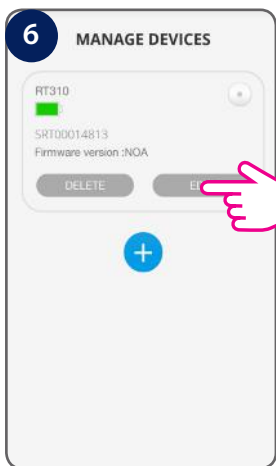

Your device appears on the screen. Tap Edit to rename it.

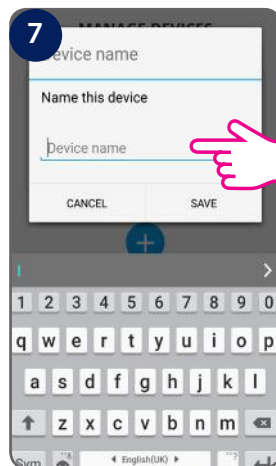

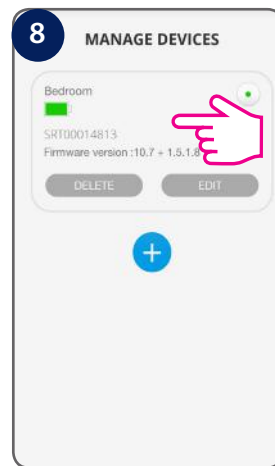

Name the device and tap Save



Tap anywhere on tile to enter the thermostat interface



Thermostat interface in schedule mode

When the thermostat is connected to the App, the  icon will appear on the App screen and the  icon will appear on the thermostat screen. Also, the hand icon  will show on the thermostat LCD.

Button functions and keys

There are few user controls for the RT310i, making this thermostat very easy to operate. These controls are shown below, along with a description of each of their functions. The temperature displayed on the LCD is the current room temperature. All the buttons on the thermostat and receiver with a description are shown below.

Thermostat

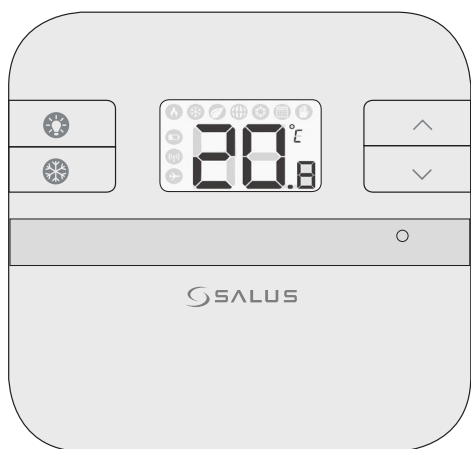

| Key | Function |
|-----|--|
| | Turn on the LCD backlight |
| | Turn On/Off the Frost Mode |
| | Press to increase setpoint temperature, press and hold to enter fast advance. |
| | Press to decrease setpoint temperature, press and hold to enter fast advance. |
| | 1. Press once to enter/exit in RF Test Mode 2. Press for 3 seconds to enter/exit Pairing Mode |

Receiver

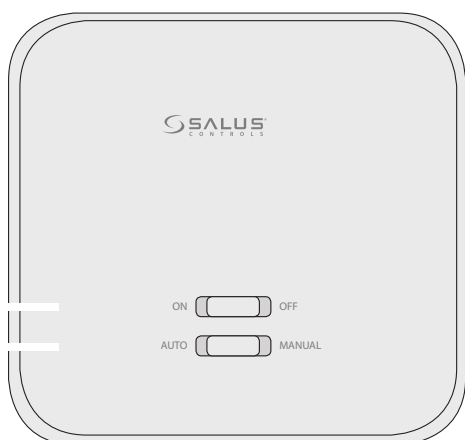

| Key/LED | Function |
|-----------|---|
| AUTO | System receiver output will switch on and off in relation to the command from the RT310i transmitter. |
| Manual | System receiver output is controlled by the On/Off slide switch. |
| ON | When in Manual Mode, ON will turn on the boiler. |
| OFF | When in Manual Mode, OFF will turn off the boiler. |
| Red Led | Receiver On, paired. |
| Green Led | Command from thermostat received. |

LCD and App icons

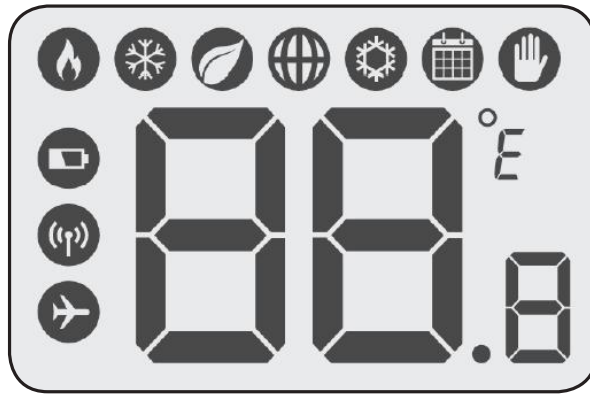

Heating Mode On



Cooling Mode On



ON when thermostat is connected to the ITG310 gateway



Frost Protection On



Schedule Mode On



Manual Override
(Permanent/Temporary override)



ON when battery is weak before battery life end



ON during RF signal transmission to RX boiler



Holiday Mode On



Temperature display

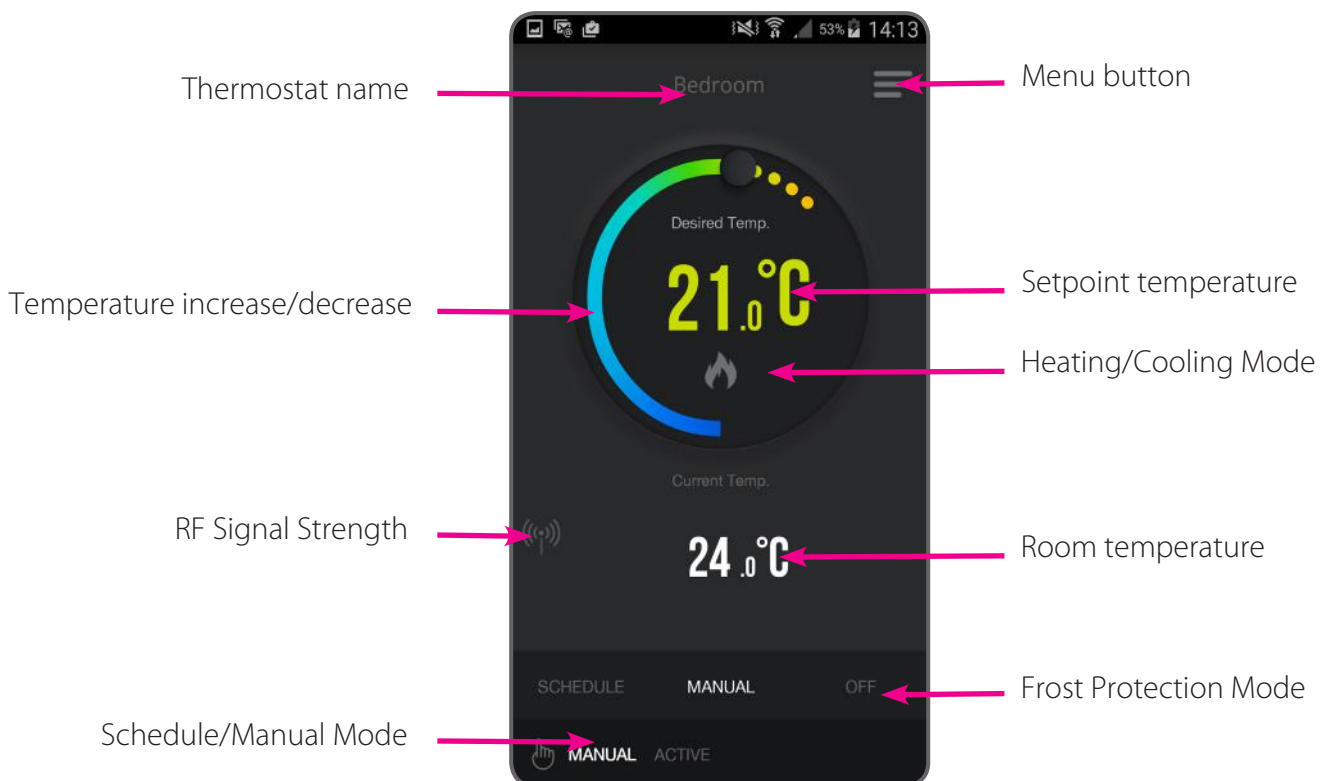

Operations

Temperature, clock, time format

When you first enter the application, your home screen will display the room temperature, the set temperature (it will operate based on the default set schedule). the thermostat will be operating in schedule mode. You can easily control your thermostat using the application. By default, the thermostat operates in heating mode, that's why you will have the flame icon on the screen. You can now start setting the time zone, changing modes, and adding schedules



Features available only on the App:

- Temperature format
 - Clock format
 - Time zone
 - Daylight Saving Time
 - Heating or Cooling Mode
 - Schedule/Manual/Off Mode
 - Holiday Mode
 - Frost Mode*
- * Also available on the device

Note: Time and date will be automatically added once you connected to the internet, based on your geo-location. What you have to do manually, though, is to select your temperature format, clock format and time zone. This can be easily done by following these steps:



Tap menu icon

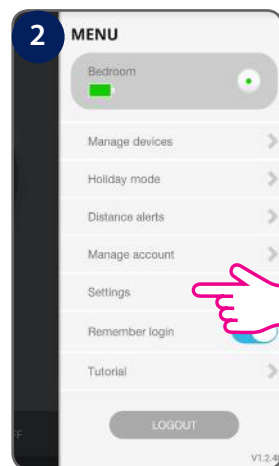

Go to settings

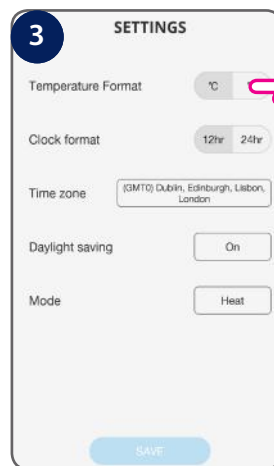

Select temperature format

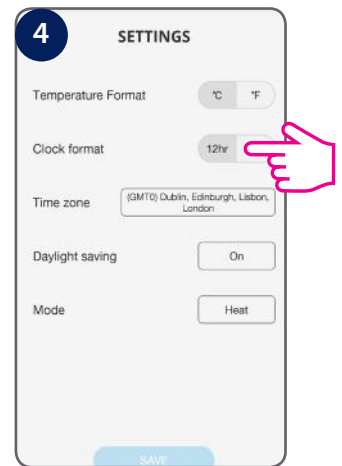

Select clock format

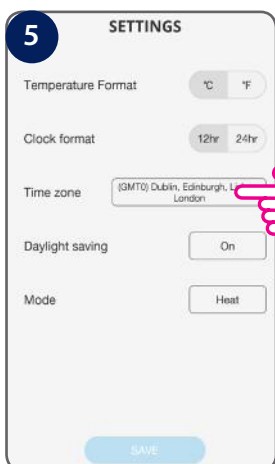

Select time zone

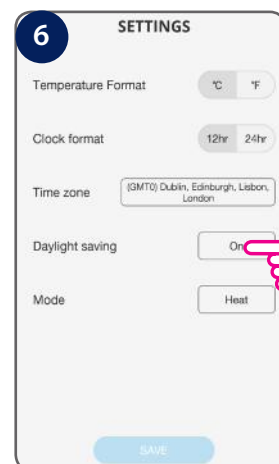

DST on/off



Tap Save

After you adjust all of your settings, tap Save. The app will then return to the home screen where you can start adding programs.

Heat/Cool Mode

You can ONLY shuffle between heat/cool mode from the App. If you want to choose a temperature that is higher than the current room temperature, make sure the thermostat is running in heat mode. If you want to set a temperature that is lower than the current room temperature, make sure you switch to cool mode.

Changing to Cool Mode



Tap menu icon

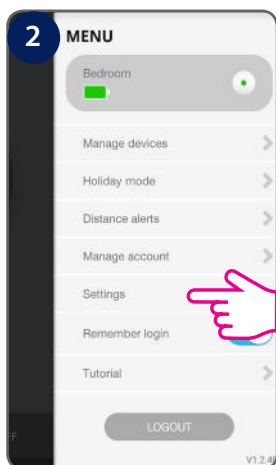

Go to settings

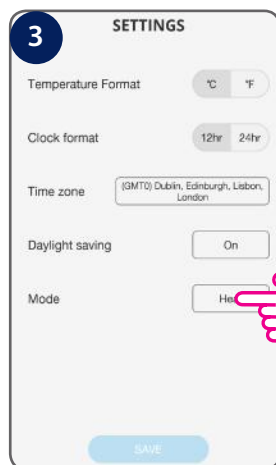

Select Cool Mode



Tap Save



Using the cursor, set the temperature

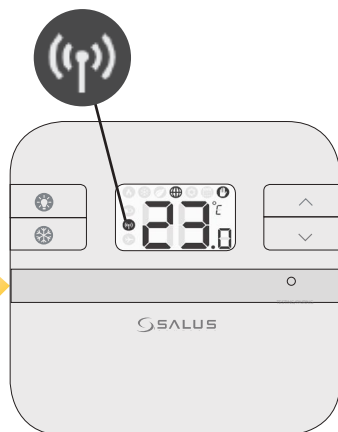

The antenna icon appears on the LCD - command received



The frost icon will turn blue and animated meaning thermostat is calling for cooling.

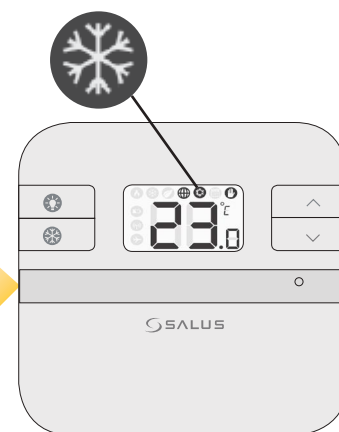

The cool mode icon will appear on the LCD, meaning thermostat is calling for cooling.

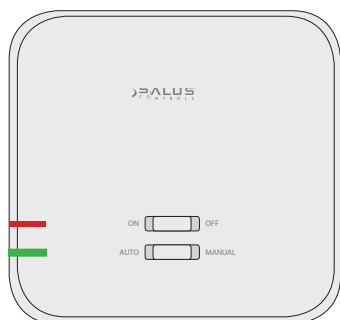

After the thermostat is calling for cooling, the green light on the RXRT510 receiver will go on steady green.

Changing to Heat Mode



Tap menu icon

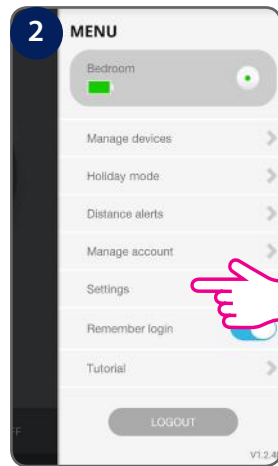

Go to settings

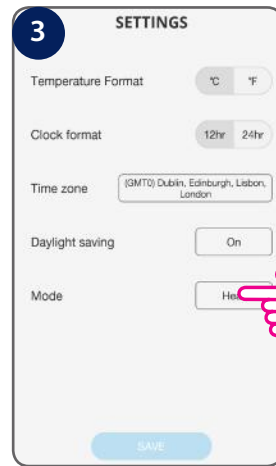

Select Heat Mode



Tap Save



Using the cursor, set the temperature

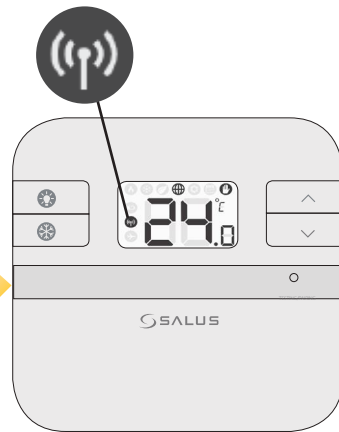

The antenna icon appears on the LCD - command received

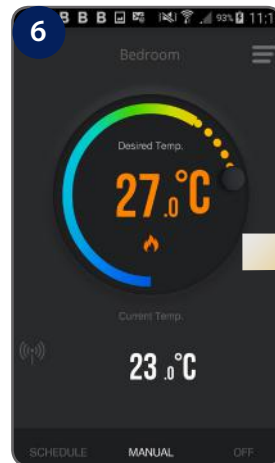

The Flame icon will turn orange and animated meaning the thermostat is calling for heat.

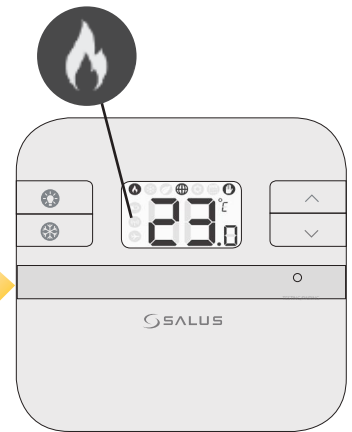

The heat mode icon will appear on the LCD, meaning thermostat is calling for heat.

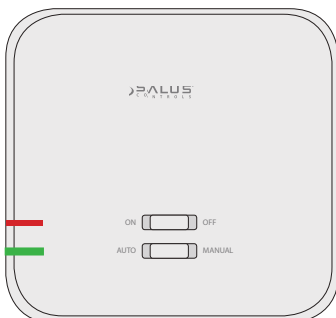

After the thermostat is calling for heat, the green light on the RXRT510 receiver will go on steady green.

Note: You can ONLY shuffle between heat/cool mode from the App. When the Internet connection is lost and the thermostat is not communicating to the gateway and App it switches to Local mode. RT310i can still run temperature control, auto program, manual override, and control RXRT510 directly. You can still change the setpoint directly from the thermostat, by pressing the \wedge or \vee keys directly from the thermostat.

Setting schedules

You can switch from Manual Mode to Schedule Mode and start adjusting programs. That's very easy to do and you need to follow the next steps. Note that there are 3 types of scheduling available, with 6 time intervals per day.

- 5+2 (Mon-Fri same, Sat-Sun same)
- Each day individual
- All week the same

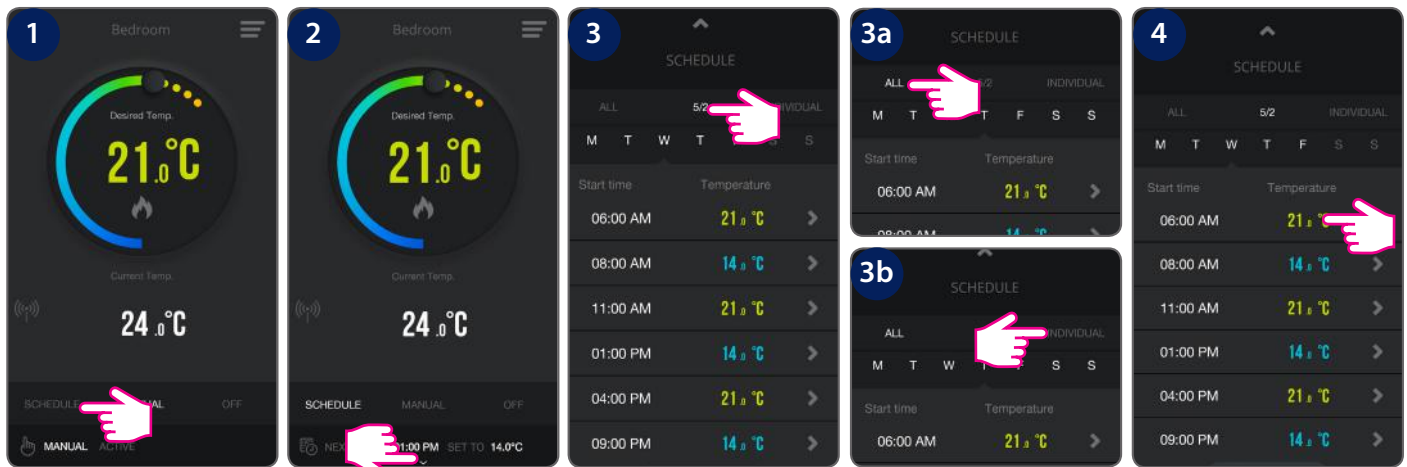

Tap schedule

Tap Arrow

Select Type: 5+2

All/Individual

Tap first interval

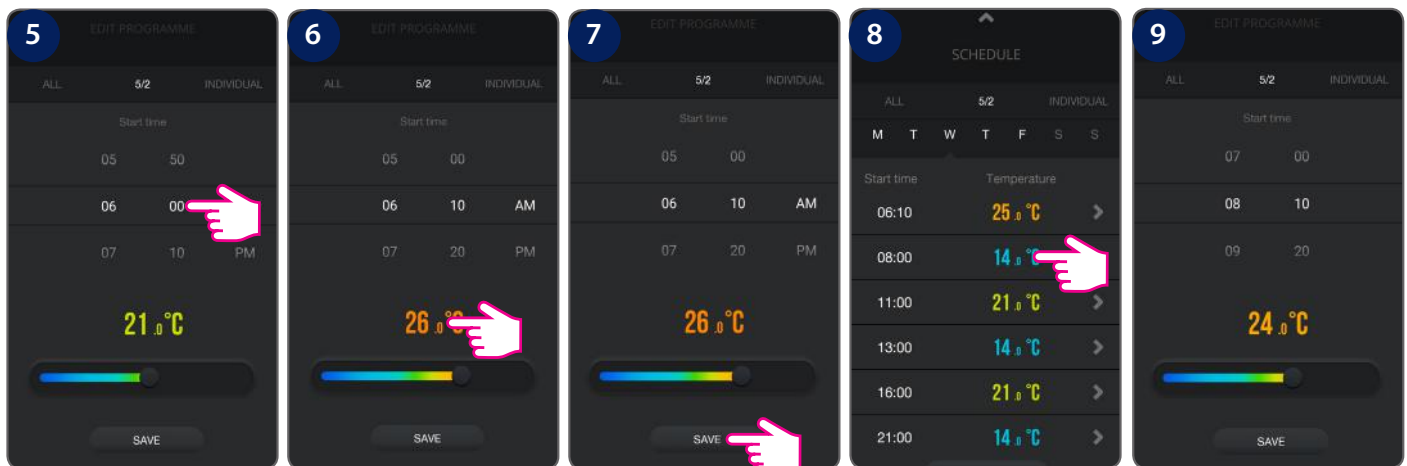

Adjust time

Adjust temperature

Tap Save

Tap next time interval.

Follow the same procedure

You need to follow the same steps for all intervals and all days in order to set schedules for the weekend days. Also, you can copy the schedules from one day to another, which comes very handy if you are setting your days individually. Please see below to see how to copy the schedules from one day to another.

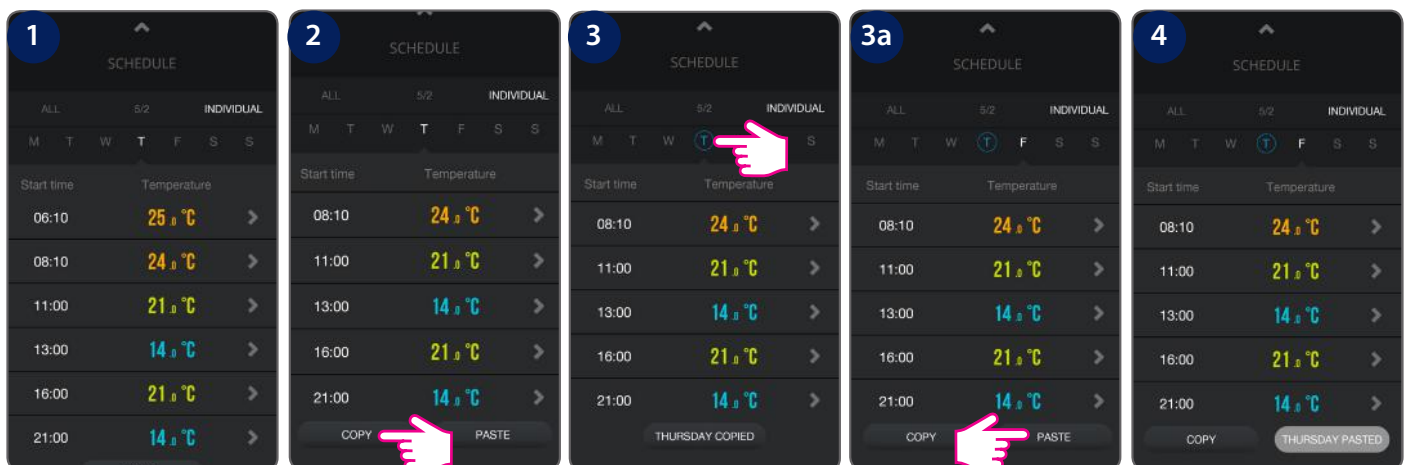

Select day

Tap Copy

Selected day will be marked with blue. Tap the day you want to paste into

Tap Paste

Schedule is saved

Temporary or Permanent Override program mode

Temporary Override

Normally thermostat is running in schedule mode.

Manual and schedule mode can only be changed in the App

In schedule mode, pressing UP or DOWN on the thermostat changes setpoint. This is Temporary Override.

You can also change the temperature directly from the App.

During Temporary Override, manually override setpoint will expire by next program P1-P6

During Temporary Override, Calendar & HAND icons are turned ON.

Via App



Temporary override mode

Via device

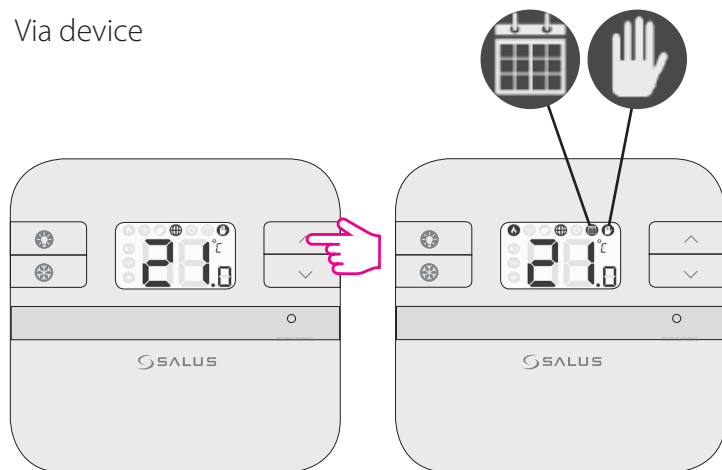

Temporary override mode

Permanent Override

In manual mode, pressing UP or DOWN changes setpoint. This is Permanent Override.

You can also change the temperature directly from the App.

During Permanent Override, manually override setpoint will run forever, until schedule model is selected from App again, or another temperature is set.

During Permanent Override, HAND icon is turned ON

Via App



Permanent override mode

Via device

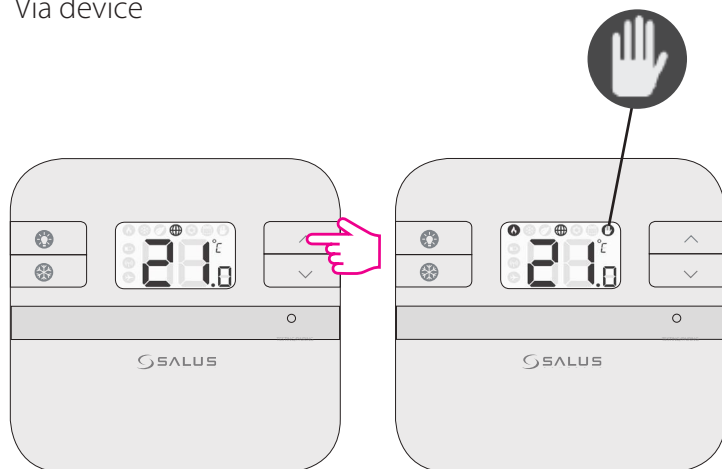

Permanent override mode

Frost Protection

Press FROST button  to activate Frost Protection.

The Setpoint temperature is automatically set to frost setpoint to prevent pipes from frosting. If the room temperature is lower than the frost setpoint, frost protection will be enabled.

Press FROST button  again to de-activate Frost Protection.

Frost Protection ON

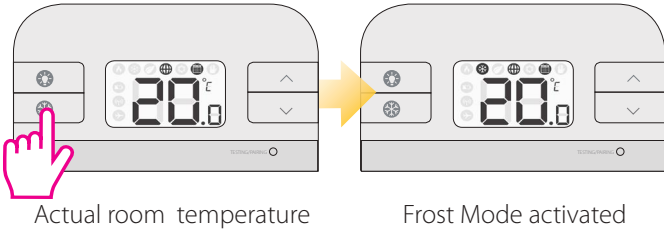

Frost Protection OFF

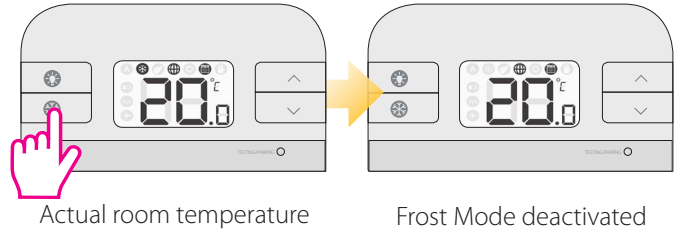

Via App

Frost Protection ON



Tap menu icon

Go to settings

Frost Protection OFF



Select temperature format

Select clock format

Frost Protection Setpoint

You can adjust the Frost Protection setpoint using the App. The setpoint range is between 5-9 °C

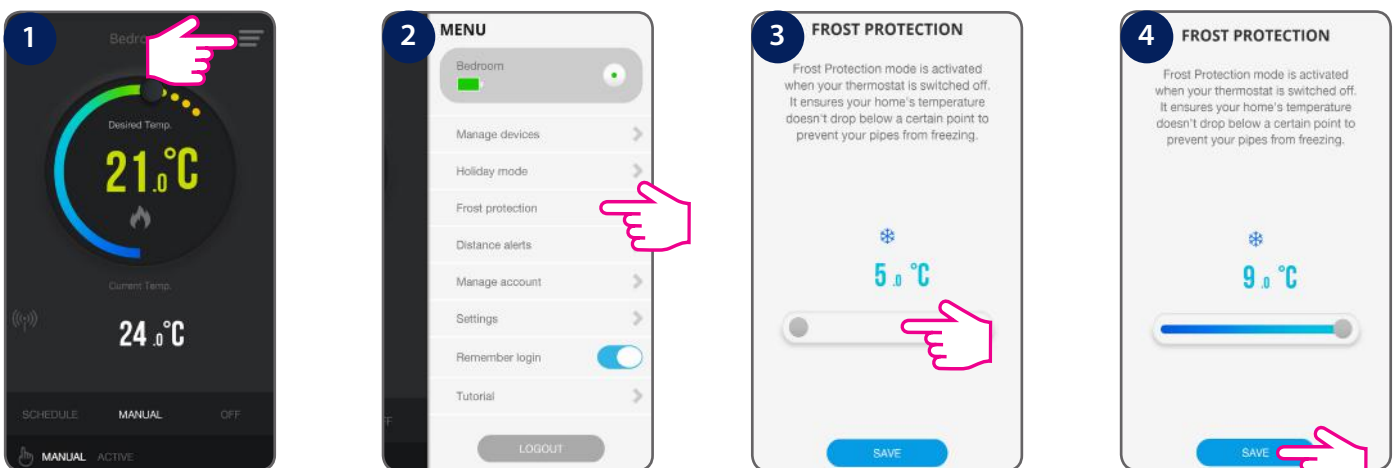

Tap menu icon

Go to Frost Protection

Adjust temperature
Default 5°C

Tap Save

Holiday Mode

You can set your RT310i to holiday mode. Thermostat will be turned OFF during this mode and no commands will be sent to the heating unit. During this mode, the thermostat will run like in Frost Protection Mode. When activated, an airplane icon appears on the display of your device  You can set Holiday mode from the App only. It can be set for maximum 31 days.



Tap menu icon

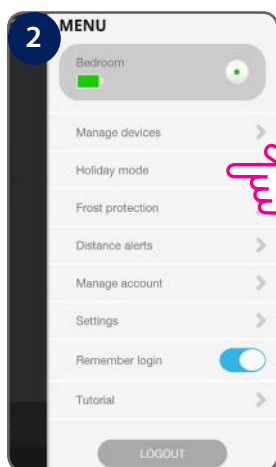

Go to Holiday Mode

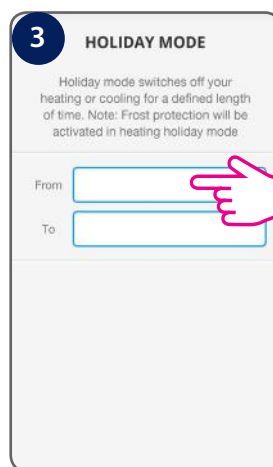

Enter holiday dates

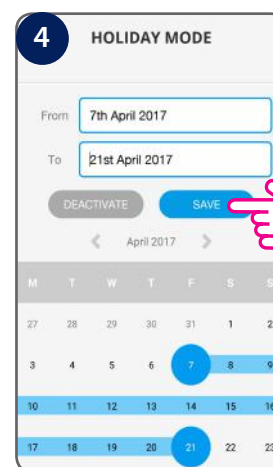

Tap Save

Distance Alerts

You can set your RT310i to notify you whenever you are a certain distance away from your home.



Tap menu icon

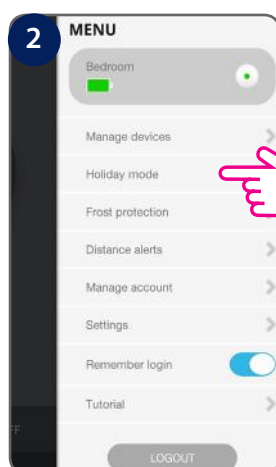

Go to Distance Alerts

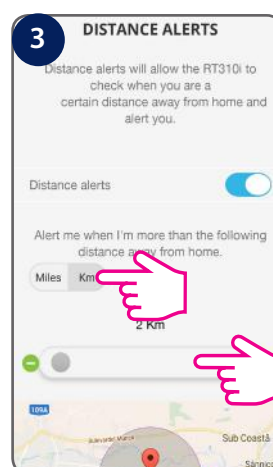

Choose miles/km and set a distance

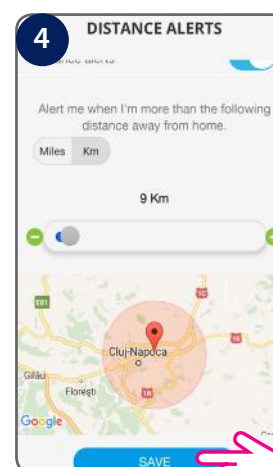

Tap Save

You can also choose to deactivate Distance Alerts in one easy step.

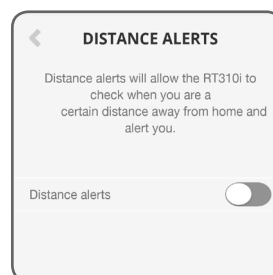
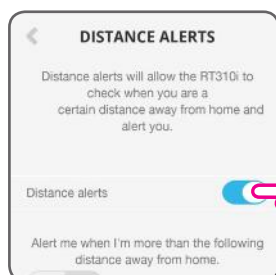

LCD backlight

- LCD backlight is activated when  or any key is pressed. The backlight will be turned off in 15 seconds after all keys are released.
- LCD backlight will not operate when battery is low.

Low battery detection

Battery voltage is checked every minute. When the battery voltage drops to a certain level, the Low-Battery warning  indicator appears.

- The thermostat functions normally during low battery. However, user must change the batteries as soon as possible before the battery is too weak for the normal operation to be assured.
- When you change the batteries, you have about 30 seconds to do so without losing your settings.

Temperatures outside operating range

Temperatures below 10 °C are displayed without the leading '0'. Temperatures exceeding the measurable range will be indicated by 'HI' for temperatures above the upper limit, and 'LO' for temperatures below the lower limit, as shown in the images.



Operating in Off-line Mode

If the Internet connection is lost and the thermostat is not communicating with the App or with the gateway, it can still be operable in off-line mode. When in off-line mode:

- The thermostat will follow the last set schedule
- Setpoint can be changed and reviewed via device

Reviewing Setpoint Temperature via device

Press  or  to review Setpoint temperature. The flame icon won't be turned on.

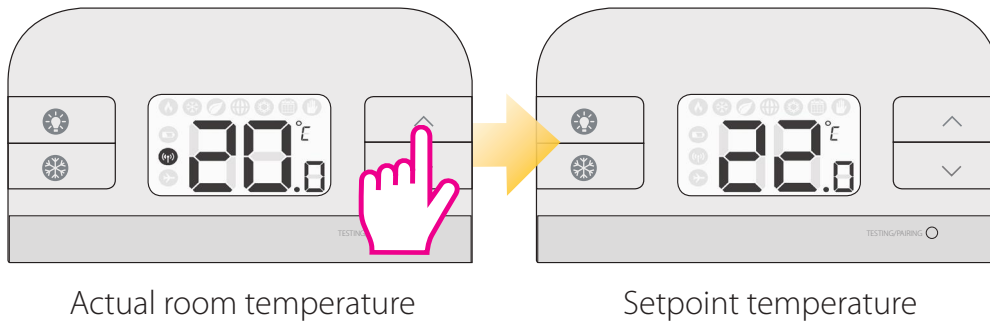

When operating in Frost protection mode, the LCD will show frost setpoint with the Frost Protection indicator displayed.

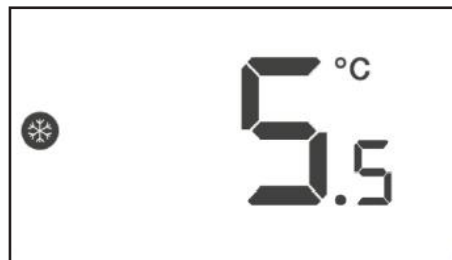

Press Backlight or wait 2 seconds without key press to return to normal operation, room temperature will be displayed.

Adjusting setpoint via device

By changing the Setpoint temperature, you are permanently altering your temperature. You can change the set point temperature very easily while you are reviewing the set point temperature. Press the UP or DOWN keys repeatedly to change the temperature setting. The set point temperature will flash to indicate that it can be changed: the temperature will be changed in 0.5°C steps per key press.

The RT310i will return to Normal mode if no keys are pressed for more than 2 seconds. Once the new Setpoint has been implemented, the change is permanently overridden until a new Setpoint is set again. Setpoint temperature cannot be changed if Frost Protection mode is enabled.

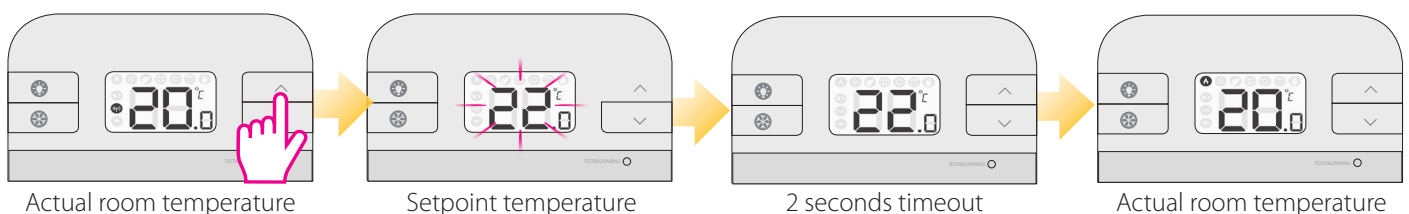

Factory reset

Remove the batteries without pressing any button. Wait 2 minutes and insert the batteries again.



Via App



Tap menu icon

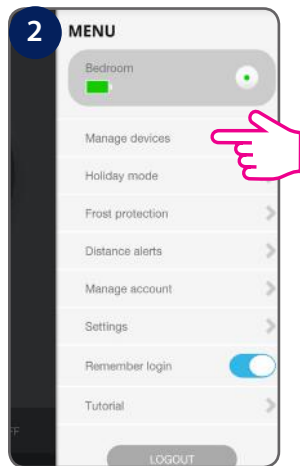

Go to Manage devices

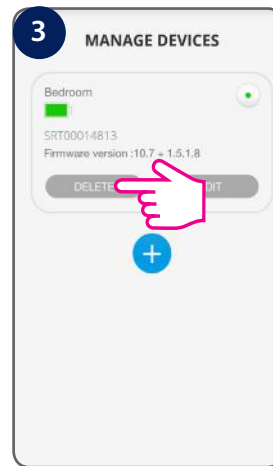

Tap delete

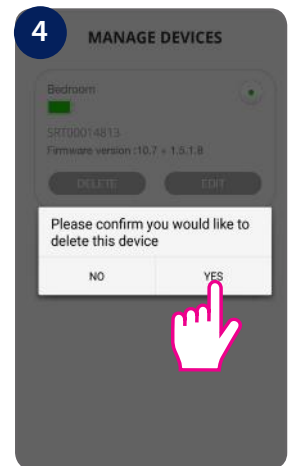

Tap Yes

After that you will need to add and set your thermostat all over again.

| Product Specification | |
|-------------------------------------|---|
| Model: | RT310iRF |
| Type: | Wireless Heating/Cooling Thermostat |
| Frequency: | 868MHz |
| Temperature | |
| Scale: | °C |
| Range: | 5.0°C - 35.0°C |
| Resolution: | 0.1/0.5°C and 0.5°C default |
| Temperature Measurement Accuracy: | Maximum +/-0.25°C at 20°C |
| Display Range: | 5.0°C - 35.0°C |
| Display Resolution: | 0.1/0.5°C and 0.5°C default |
| Frost Protection | |
| Setting: | 5 °C |
| Setpoint Temperature Range: | 5 °C to 9°C |
| thermostat | |
| Power Source: | 2 AA-sized Alkaline Batteries for a minimum of 12 months operation. |
| Receiver | |
| Power Source: | 230Vac 50Hz |
| Switch Rating | |
| Switching Voltage: | 230V/50Hz |
| Switching Current: | 16A resistance 8A inductance |
| Protection Rating: | IP 30 |
| Environment | |
| Operating Temperature/ Humidity: | 0°C ~ 50°C, 10% – 90% non-condensing |
| Storage Temperature/ Humidity: | -20°C~- 60°C, 10% – 90% non-condensing |

Warranty

SALUS Controls warrants that this product will be free from any defect in materials or workmanship, and shall perform in accordance with its specification, for a period of two years from the date of installation. SALUS Controls sole liability for breach of this warranty will be (at its option) to repair or replace the defective product.

Customer Name:

Customer Address:

..... Post Code:

Tel No: Email:

Company Name:

Tel No: Email:

Installation Date:

Installer Name:

Installer Signature:

SALUS Controls PLC

SALUS House

Dodworth Business Park South,
Whinby Road, Dodworth,
Barnsley S75 3SP, UK.

Sales: T: +44 (0) 1226 323961
E: sales@salus-tech.com

Technical: T: +44 (0) 1226 323961
E: tech@salus-tech.com

www.salus-controls.com



SALUS Controls is a member of the Computime Group

Maintaining a policy of continuous product development, SALUS Controls plc reserves the right to change specification, design and materials of products listed in this brochure without prior notice.

For the latest PFD Instruction Manual, go to www.salus-manuals.com